

 Product Center



 TV Channel



 Wechat Contact



<https://www.xheatpress.com/>

XINHONG GROUP LIMITED

Factory Address: Baijin Industrial Zone, Baizhang Town, Minqing County, Fuzhou City, Fujian Province, China
Office Address: 923-932#, 9/F., La Cite Block 40, No. 1-1 High-tech Avenue, High-tech Zone, Fuzhou City, Fujian Province, China
Phone: 86-0591-83952222
Fax: 86-0591-83805930
Website: www.xheatpress.com
Email: sales@xheatpress.com

Solvent-less Rosin Presss & Accessories

Featured Supplier

ABOUT US

Xinhong Group reorganized and expanded business in 2011, and has acquired quality management system certification of ISO9001, ISO14000, OHSAS18001 and CE product labels. Solvent-less rosin press is new product line for Xinhong Group since 2014, our team are offering an extensive range of equipment, accessories, and innovative process solutions that are based on advanced technology and a real knowledge of the plant extraction industry. Our team have designed and delivered the most reliable, efficient, innovative, and cost-effective solutions for the process and overall project implementation.



Xinhong Capability

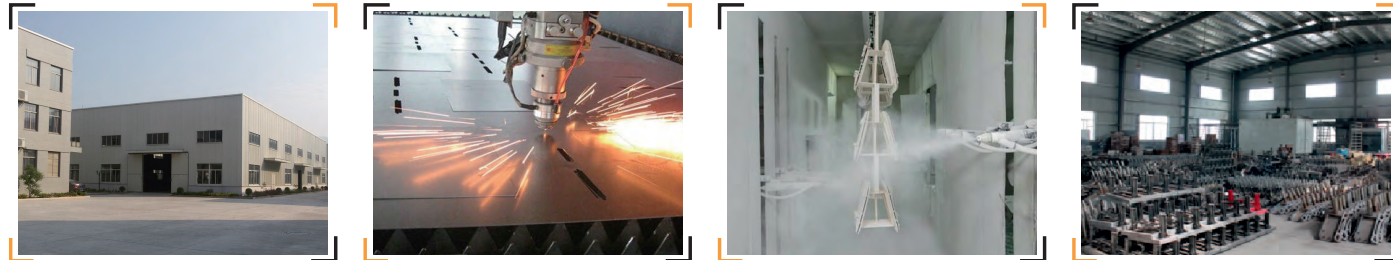

CONTENTS

EasyPresso Personal Manual Series

- 450kg Min Rosin Press MRP450.....01/02
- 2 Tons Hand Twist Rosin Press MRP2.....03/04

EasyPresso Personal Hydraulic Series

- Rosin Press Plates Kit.....05/06
- 6 Tons Hydraulic Rosin Press.....07/08

EasyPresso Industrial Mate Series

- 10 Tons Electric Rosin Press.....09/10
- 30 Tons Air & Hydraulic Press.....11/12

Rosin Press Accessories.....13-16

Rosin Press Controller Instruction.....17-18

Which Rosin Press is Best for Me?19-20



❖ This Press Does Not Ship to Germany

▼ Technical Parameters

Model	MRP450
Voltage	110V/220V
Power	100W
Heat Plates	50*75mm(Food Grade Aluminum Plates)
Controller	Digital Pid Controller
Max. Temperature	450 °F / 232 °C
Temp. Accuracy	±4 °F / 2 °C
Max. Pressing Force	450kg /1000lbs
Working Style	Locking Lever Mechanism
Pressure Adjustment	Pressure Nut
Suggested Load Material	2-3 Grams
Dimension (L*W*H)	19*12*26cm
Packaging (L*W*H)	29*20*31cm
Product Weight	3.9kg
Shipping Weight	4.6kg
Certificate	CE

Personal rosin press is the most lightweight model in our press line (G.W. only 4.6kg). Despite being compact, this manual machine generates up to 450kg of pressing force. The press features sturdy construction, a locking lever mechanism, adjustable pressure, 50 x 75mm dual heating insulated solid aluminum plates, temperature controls located at the top of the press. Portable, sturdy and efficient, it is perfect for personal desktop operating or pressing during travel.



● Digital Pid Controller

The extraction press digital controller located at the top, it is used to set temperature for its 50 x 75mm dual heating plates, temperature scale options (°F or °C) and press timer.



● Portable & Personal Press

Very lightweight (under 4kg) and easy to carry, almost same height like a 500ml Coke bottle. The heat extraction press is an ideal personal press and it is fun to operate, and no other equipment is required to start pressing.

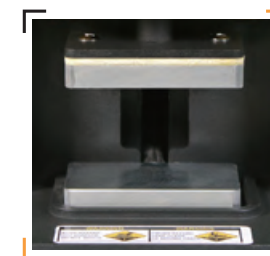

● Food Grade Aluminum Plates

50 x 75mm heat-insulated solid 6061 food grade aluminum plates with two separate heating elements heat up evenly and keep the temperature for the setting time precisely.

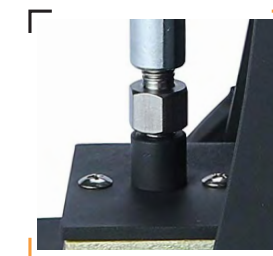

● Sturdy Made & Adjustable Pressure

The EasyPrsso generates Max. 450kg pressing force, the knob above the heating plates also allows you to adjust the pressure between the plates to accommodate different plant material volume.

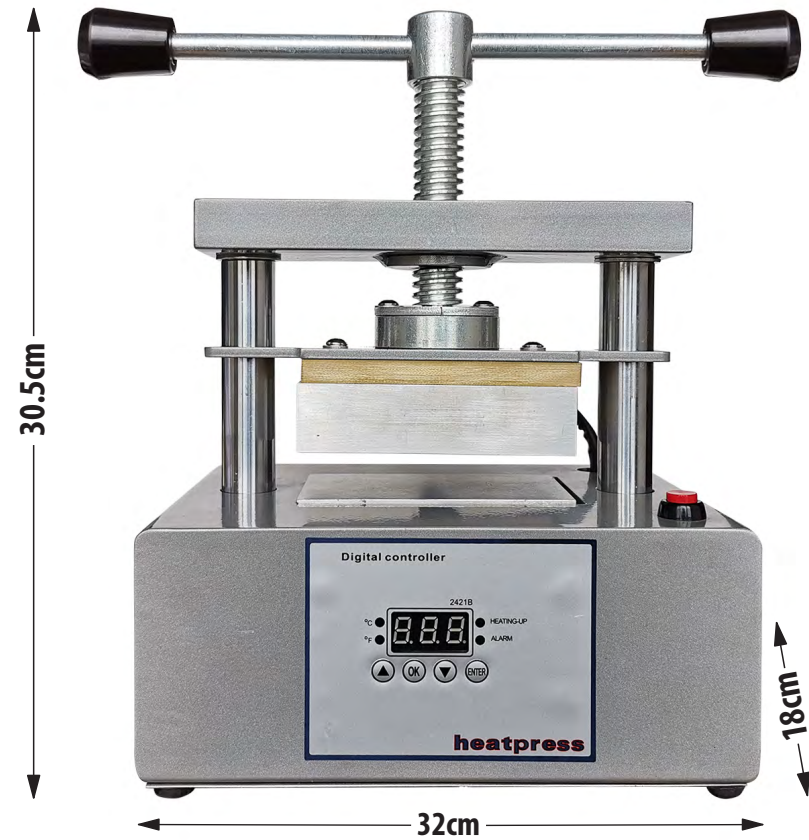

▼ Technical Parameters

Model	MRP2
Voltage	110V/220V
Power	800W
Heat Plates	75*120mm (Food Grade Aluminum Plates)
Controller	Digital Temp. & Timer Controller
Max. Temperature	450 °F / 232 °C
Temp. Accuracy	±4 °F / 2 °C
Max. Pressing Force	2 Tons
Working Style	Threads Locking Mechanism
Pressure Adjustment	Hand Twist
Suggested Load Material	3-6 Grams
Dimension (L*W*H)	32*18*30.5cm
Packaging (L*W*H)	43*37*34cm
Product Weight	17kg
Shipping Weight	19kg
Certificate	CE

EasyPresso MRP2 Twist Rosin Press is easy to use when extracting herbs at home. Just set your desired settings on the controller, wait until the insulated heat plates heat up, and rotate the twist handle to apply necessary pressure. When done pressing, rotate the handle counterclockwise, remove your pressed material, and enjoy the freshly squeezed oil.



● **Digital Pid Controller**
The extraction press digital controller located at the top, it is used to set temperature for its 75 x 120mm dual heating plates, temperature scale options (°F or °C) and press timer.

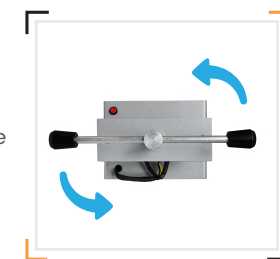

● **Easy to Use**
Just rotate the twist handle to apply necessary pressure. When done pressing, rotate the handle counterclockwise, remove your pressed material, and enjoy the freshly squeezed oil.

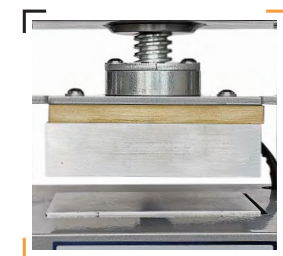

● **Food Grade Aluminum Plates**
75 x 120mm heat-insulated solid 6061 food grade aluminum plates with two separate heating elements heat up evenly and keep the temperature for the setting time precisely.



● **Heavy Pressure Manual Press**
The heat extraction press can generate 2 tons pressing force between its heat plates, which rivals many hydraulic, pneumatic, or electric heat presses in power.

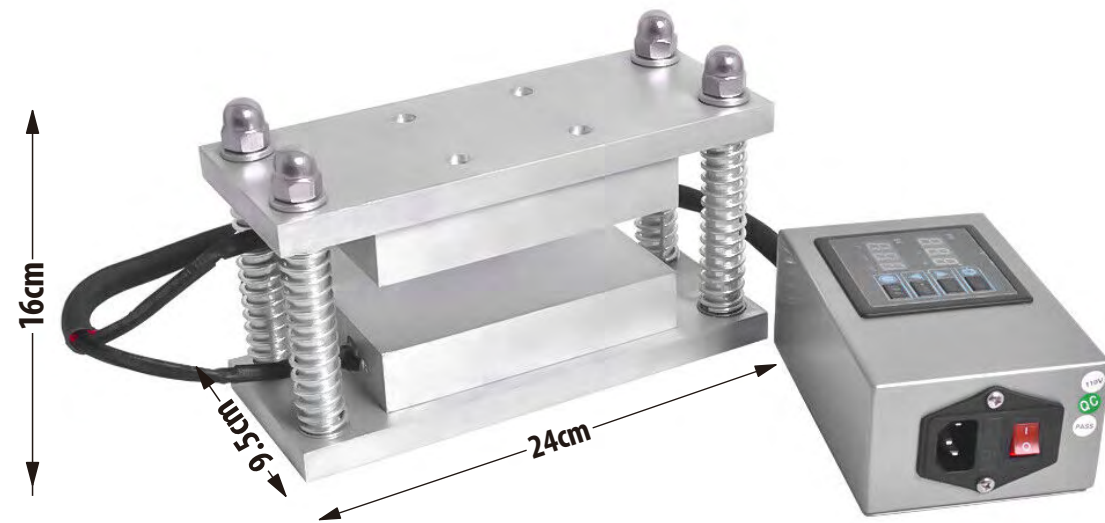

▼ Technical Parameters

Model	RPKT-2
Voltage	110V/220V
Power	800W
Heat Plates	75*150mm (Food Grade Aluminum Plates)
Controller	Two Channel Temp. & Timer Controller
Max. Temperature	450 °F / 232 °C
Temp. Accuracy	±2 °F / 1 °C
Max. Pressing Force	Max. 20 Tons
Working Style	Used on Shop Press
Pressure Adjustment	Hydraulic Jack
Suggested Load Material	3-15 Grams
Dimension (L*W*H)	24*9.5*16cm
Packaging (L*W*H)	39*16*25cm
Product Weight	5.5kg
Shipping Weight	6.8kg
Certificate	CE

EasyPresso Rosin Press Plates Kit works with 10 to 20 ton hydraulic or air-operated shop presses (shop press not included) and comes with a compact temperature and timer controller. This product is capable of pressing up to 20 ton pressure at low temperature.



Precise Temp. & Timer Controls
EasyPresso is equipped with a precise two-channel temperature and timer controls. You can program your press with desired temperature separately for each plate, temperature scale (°F or °C) and set your timer.



Feature with Shop Press
Caged Dual Heating Insulated Plates For 10-20 Ton Hydraulic or Air-Operated Shop Press; Powerful & Heavy-Duty. DIY for your own press and saves money.



Food Grade Aluminum Plates
75 x 150mm heat-insulated solid 6061 food grade aluminum plates with two separate heating elements heat up evenly and keep the temperature for the setting time precisely.



Designed Magnetic Feet
Magnetic feet on the controller which allow you to secure it anywhere on the shop press.



▼ Technical Parameters

Model	HRP6
Voltage	110V/220V
Power	800W
Heat Plates	75*120mm (Food Grade Aluminum Plates)
Controller	Digital Temp. & Timer Controller
Max. Temperature	450 °F / 232 °C
Temp. Accuracy	±2 °F / 1 °C
Max. Pressing Force	6 Tons
Working Style	Hydraulic
Pressure Adjustment	Hydraulic Jack
Suggested Load Material	3-14 Grams
Dimension (L*W*H)	35*15*58cm
Packaging (L*W*H)	40*32*64cm
Product Weight	20kg
Shipping Weight	26kg
Certificate	CE

EasyPresso HRP6 generates 6 Tons of crushing force and is equipped with 75 x 120mm insulated solid aluminum dual heating plates, precise temperature and timer control with a built-in power conservation option, and a carrying handle. The pressure and ram speed is controlled by simple pumping of the cranking handle.



Precise Temp. & Timer Controls
EasyPresso MRP6 is equipped with a precise digital PID temperature and timer controls. You can program your press with desired temperature separately for each plate, temperature scale (°F or °C) and set your timer.



Easy to Operate
All-In-One, No extra equipment required. Ergonomic handle design allows you to move the press conveniently.



Food Grade Aluminum Plates
75 x 120mm heat-insulated solid 6061 food grade aluminum plates with two separate heating elements heat up evenly and keep the temperature for the setting time precisely.



Suction Cups
4 suction cups at bottom grab the extraction press for strong & stable hold on bench or desk.

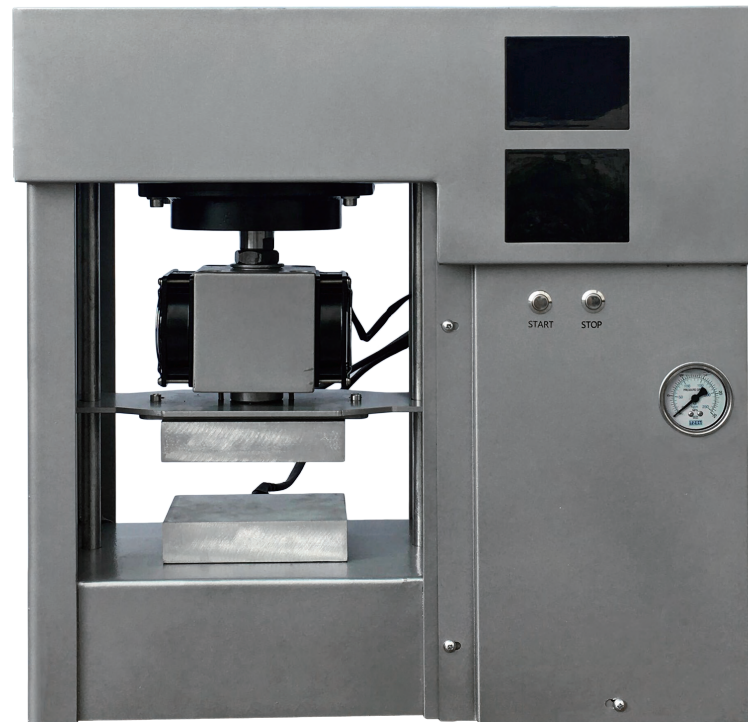

▼ Technical Parameters

Model	ERP10
Voltage	110V/220V
Power	1000W
Heat Plates	100*150mm (Food Grade Aluminum Plates)
Controller	Dual Temp. & Timer Controller
Max. Temperature	450°F / 232 °C
Temp. Accuracy	±2 °F / 1 °C
Max. Pressing Force	10 Tons
Working Style	Hydraulic Electric / Hybrid
Pressure Adjustment	Control Panel
Suggested Load Material	3-20 Grams
Dimension (L*W*H)	/
Packaging (L*W*H)	62*42*76cm
Product Weight	73kg
Shipping Weight	93kg
Certificate	CE

EasyPresso Rosin Press ERP10 is electrical powered, Say Goodbye to Oil-leaking hydraulic Press and noisy air compressor of pneumatic press. Just hit "Press" button to start pressing and hit "Release" to separate. This press is equipped with dual precise temperature and timer controls. It's sturdy made press and can generate Max. 10T pressing force.



Precise Temp. & Timer Controls
EasyPresso ERP10 is equipped with dual precise temperature and timer controls. You can program your press with desired temperature separately for each plate, temperature scale (°F or °C) and set your timer.



Certified Motor & Seal System
This press uses electricity to power its hydraulic cylinders. Electric motor which is been certified by IECEE-CB guaranteed stability. Sealed mechanism design ensures that the machine will not leak oil.

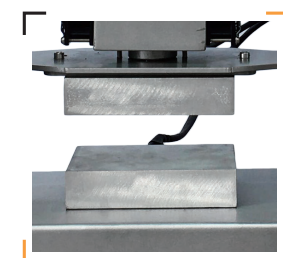

Multiple Sizes-Food Grade Plates
10 x 15cm // 12 x 17.5cm / 7.5 x 20cm etc. heat-insulated food grade 6061 solid aluminum plates with two separate heating elements heat up evenly.



Electric Hands-Free Style
Hands-free style, just hit "Press" button to start pressing and hit "Release" button to separate. You can also read the pressure from the pressure gauge.



▼ Technical Parameters

Model	HRP30
Voltage	110V/220V
Power	1000W
Heat Plates	75*200mm (Food Grade Aluminum Plates)
Controller	Dual Temp. & Timer Controller
Max. Temperature	450°F / 232 °C
Temp. Accuracy	±4 °F / 2 °C
Max. Pressing Force	30 Tons
Working Style	Hydraulic / Air Hand Jack
Pressure Adjustment	Press Button/Cranking handle
Suggested Load Material	3-30 Grams
Dimension (L*W*H)	55*33.5*72.2cm
Packaging (L*W*H)	65*43*90cm
Product Weight	111kg
Shipping Weight	126kg
Certificate	CE

EasyPresso HRP30 is industrial strength hybrid heat extraction press produces up to 30 Tons of force and is built for mass rosin production. The heating plates are made of food-grade stainless steel or insulated aluminum. Independent controller allows you to set temperature for upper and bottom platens and uses a lower recommended temperature settings to produce premium quality oil with the best aroma, taste, and clarity.

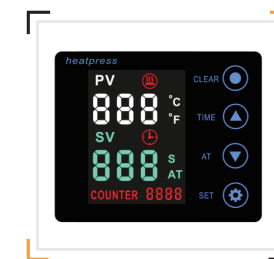

Precise Temp. & Timer Controls
EasyPresso HRP30 is equipped with dual precise temperature and timer controls. You can program your press with desired temperature separately for each plate, temperature scale (°F or °C) and set your timer.



3IN1 Easy to Use
Manul/Semi-auto/Auto 3 IN1 Device, freely switch between manual and pneumatic pressure. Make sure HRP30 meets different working condition.



Multiple Sizes-Food Grade Plates
7.5 x 20cm, 10 x 20cm etc. heat-insulated food grade 6061 solid aluminum plates with two separate heating elements heat up evenly.



Different Level Hydraulic
EasyPresso HRP30 is sturdy made and able to work with different level hydraulic jack, i.e. 12T, 20T and 30T. User can read-out the pressure from the pressure gauge to instruct the pressure will be applied.

❖ Rosin Press Mold

Model #: RPM510/ RPM515
 Material: Food Grade 6061 Aluminum
 Size: 5 x 10cm, 5 x 15cm, etc.
 Packaging: Gift Box



Highlights

- Perfect Workmanship
- Compacts Your Herbs
- Increases Yields
- Reduces Filter Bag Blowouts

❖ Rosin Press Mold Presser

Model #: RMP
 Structure: Lever Mechanism
 Application: Kinds of Press Molds,
 Pollen-Press Molds
 Packaging:



Highlights

- Compacts Your Rosin Molds
- Increases Yields
- Better Pressing Result
- Reduces Filter Bag Blowouts

❖ Rosin Pollen-Press Mold

Model #: RPPM27/ RPPM35
 Material: 304 Stainless Steel
 Size: 2.7 x 0.3 x 10cm, 3.5 x 0.3 x 12cm
 Packaging: Gift Box



Highlights

- Perfect Workmanship
- Easy to Clean & Dishwasher Safe
- Compacts Your Herbs
- Increases Yields
- Reduces Filter Bag Blowouts

❖ Sauce Heat Plate

Model #: SHP12
 Material: Food Grade 6061 Aluminum
 Controller: Digital PID Temp. Controller
 Size: 12 x 12cm
 Packaging: Regular Packaging



Highlights

- Food Grade Contact Surface
- Even Temp. is Delivered & Detected.
- Max. 200 °C

❖ **Cooling Plate for Collection**

Model #: CP15
 Material: Food Grade 6061 Aluminum
 Mark: Cooled in Refrigerator Before Use
 Size: 15 x 15cm
 Packaging: Regular Packaging

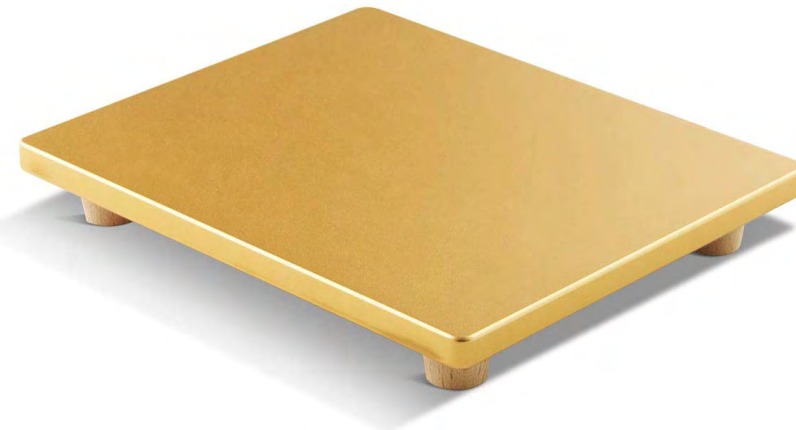

Highlights

- Food Grade Contact Surface
- Cooling Rosin Oil Purpose
- Conveniently placing in Refrigerator

❖ **Rosin Filter Bags**

Model #: RRB
 Material: 100% Dye-Free Food Grade Nylon Mesh
 Spec.: 37/90/120/160µm
 Size: 5 x 10cm, 5 x 15cm, etc.
 Packaging: At Buyer's Option



Highlights

- Super Tight Folded Seam Nylon
- Double-Stitches Eliminates Breaking
- Boiling and Solvent Resistant
- Withstand Temperature 200°C

❖ **Rosin Wax Collection Tool**

Model #: RWCT
 Material: 304 Stainless Steel
 Size: 5 Double-Ended Tools
 Packaging: Free Carrying Case



Highlights

- Portable, Fits in Pocket
- Working Great with Wax
- Ten Precision Edges, Variety of Shapes















❖ **Rosin Parchment Paper**

Model #: RPP
 Material: Double-Side Coated with Natural Silicone
 Thickness: 30gsm, 40gsm, ect.
 Packaging: At Buyer's Option



Highlights

- Non-Stick; Hot-Plate Safe
- Heat Resistant up to 230°C
- Safe to use with Scrapers
- Made by Natural Materials
- Reusable up to 2-4 times

- 1. Press Set  button on the control panel (Fig. 1) to go to the temperature setting mode for the top platen.
- 2. Press Up  or Down  buttons to select the desired temperature (Fig.2). The selected temperature is shown on the  line of the display. Tip: Enter the temperature either in °F or °C; you will be able to select the temperature scale later.
- 3. Press Set  button again (Fig. 3) to go to the temperature setting mode for the bottom platen.
- 4. Press Up  or Down  buttons to select the desired temperature (Fig.4). The selected temperature is shown on the  line of the display.
- 5. Press Set  button again (Fig.5) to go into the timer setting mode.
- 6. Press Up  or Down  buttons to select the desired time in seconds (Fig.6).
- 7. Press set  button to go to the temperature scale selection mode (Fig. 7). TIP: Depending on your machine's default settings, you may either see "F" or "C" on the display indicating the currently selected temperature scale (°F or °C).
- 8. Press Up  or Down  buttons to select either °F or °C (Fig. 8) OR skip this step if you are satisfied with the current selection.
- 9. Press Set  button TWO times (Fig. 9) to record all control panel's settings. The platens start heating, and the heating icons are now displayed on the screen (Fig.10).
- 10. Wait until the plates reach the desired temperature and the heat icons are turned off (Fig. 11).
- 11. Press the TIMER button on the control panel (Fig. 12). The control panel starts showing a countdown. Wait until the countdown ends and the press starts beeps, then press the TIMER button again to turn off the timer and stop beeping.

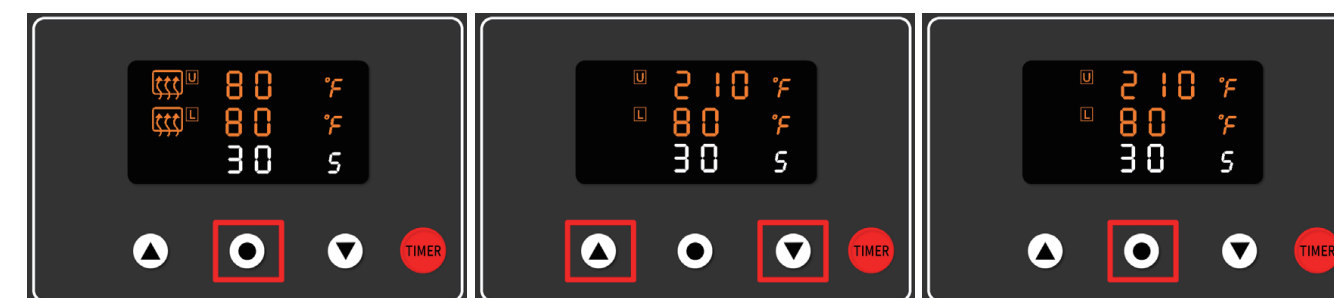

Fig. 1

Fig. 2

Fig. 3

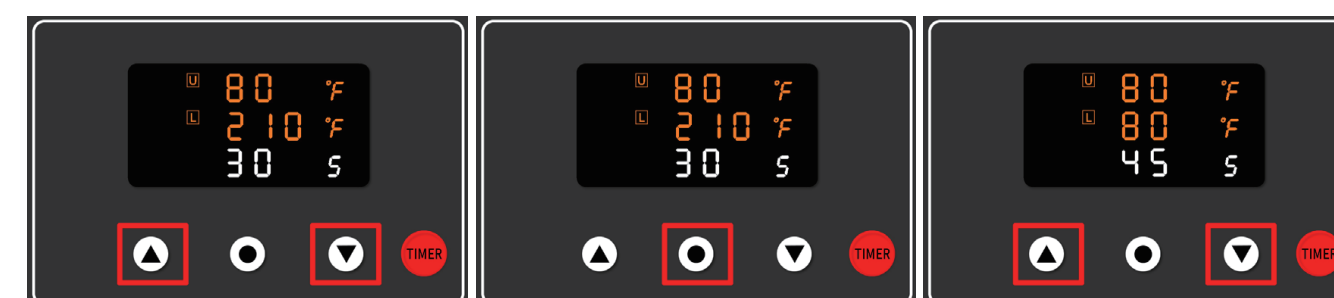

Fig. 4

Fig. 5

Fig. 6

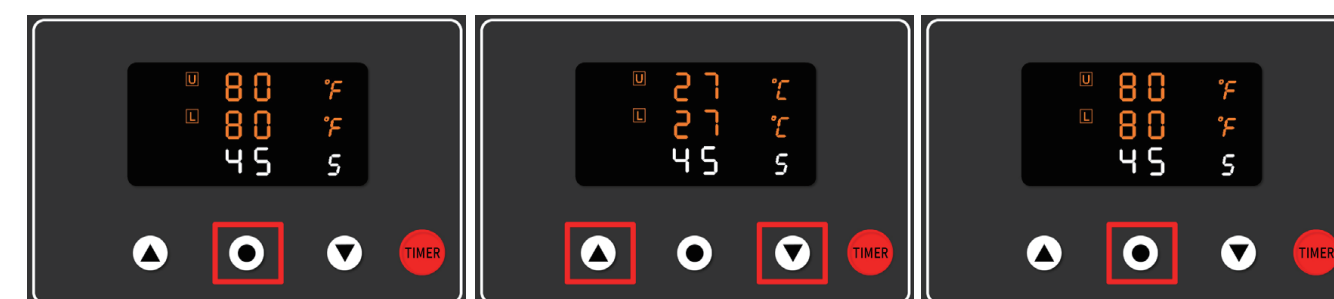

Fig. 7

Fig. 8

Fig. 9

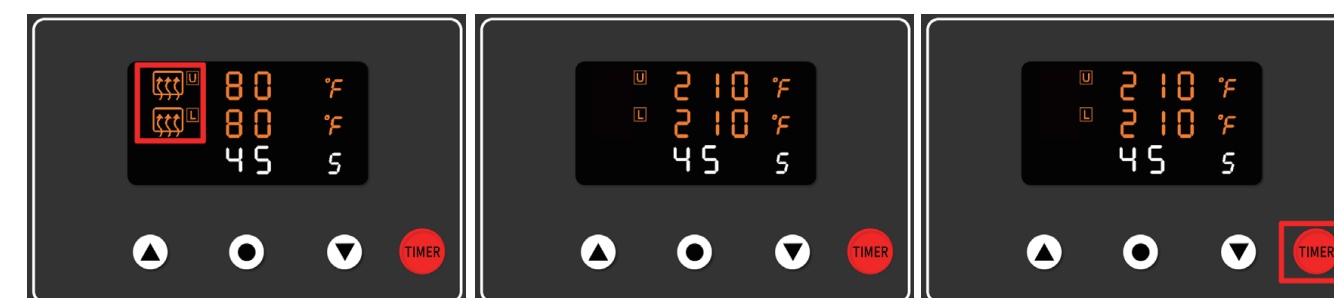

Fig. 10

Fig. 11

Fig. 12

Which Heat Extraction Press is Best for Me?

Using the chart below to help decide which rosin press is best for your personal or commercial use.

SKU	MRP450	MRP2	RPKT-2	HRP6	ERP10	HRP30
Machine Photo						
Model Name	Mini Rosin Press	Twist Rosin Press	Rosin Press Plates Kit	6T Hydraulic Rosin Press	10T Electric Rosin Press	Industrial Rosin Press
Max. Force	450kg	2 Tons	20 Tons	6 Tons	10 Tons	12/ 20/ 30 Tons
Operation System	locking Lever Mechanism	Hand Twist	W/Shop Press	Hydraulic	Electric	Hydraulic/Pneumatic
Heat Plates Size	5 x 7.5cm	7.5 x 12cm	7.5 x 15cm/7.5 x 20cm	7.5 x 12cm	10 x 15cm	7.5 x 20cm
Control System	Digital Temp. & Timmer Controller	Digital Controller	Two Channel Temp. & Timer Controller	Digital Temp. & Timmer Controller	LCD Temp. & Timmer Controller	LCD Temp. & Timmer Controller
Machine Dimension	19 x 12 x 26cm	32 x 18 x 30.5cm	24 x 9.5 x 16cm	35.5 x 30 x 56cm	/	55x33.5x72.2cm
Materials Loaded	2-3 Grams	3-6 Grams	3-12 Grams	3.5-12 Grams	3.5-30 Grams	10-56 Grams